

FROM A TO:	
D	43'-7 1/2"
M1	35'-6 3/4"
N2	10'-8"
P	12'-4 1/4"
P1	8'-10"
Q	20'-2 1/4"
R	21'-8"
R1	25'-7 1/4"
S	35'-1"
T	16'-10 1/2"
U	32'-3 3/4"

FROM B TO:	
C	43'-7 1/2"
M1	37'-1 1/4"
N2	35'-5 1/2"
P	30'-0 1/2"
P1	30'-4 1/2"
Q	16'-10 1/4"
R	31'-5 1/2"
R1	32'-10 3/4"
S	23'-10 1/2"
T	40'-3 1/2"
U	8'-5"

FROM C TO:	
B	43'-7 1/2"
M1	18'-10 3/4"
N2	33'-4 3/4"
P	16'-3 1/2"
P1	19'-2"
Q	30'-6"
R	12'-5"
R1	12'-9 3/4"
S	27'-5 1/2"
T	6'-2"
U	35'-8 3/4"

FROM D TO:	
A	43'-7 1/2"
M1	21'-7 3/4"
N2	47'-6 1/4"
P	31'-10 1/2"
P1	34'-9 3/4"
Q	28'-5"
R	25'-11 3/4"
R1	24'-3 1/4"
S	9'-8 1/4"
T	37'-1 1/4"
U	17'-5"

FROM T TO:	
M1	21'-11"
N2	27'-2 3/4"
P	11'-1 3/4"
P1	13'-5"
Q	25'-10 1/4"
R	11'-1 3/4"
S	13'-5"
T	27'-5"

FROM U TO:	
N1	28'-9 1/4"
N2	33'-1"
P	23'-5"
P1	24'-7"
Q	13'-1"
R	23'-5"
R1	24'-7"
S	15'-11 1/2"

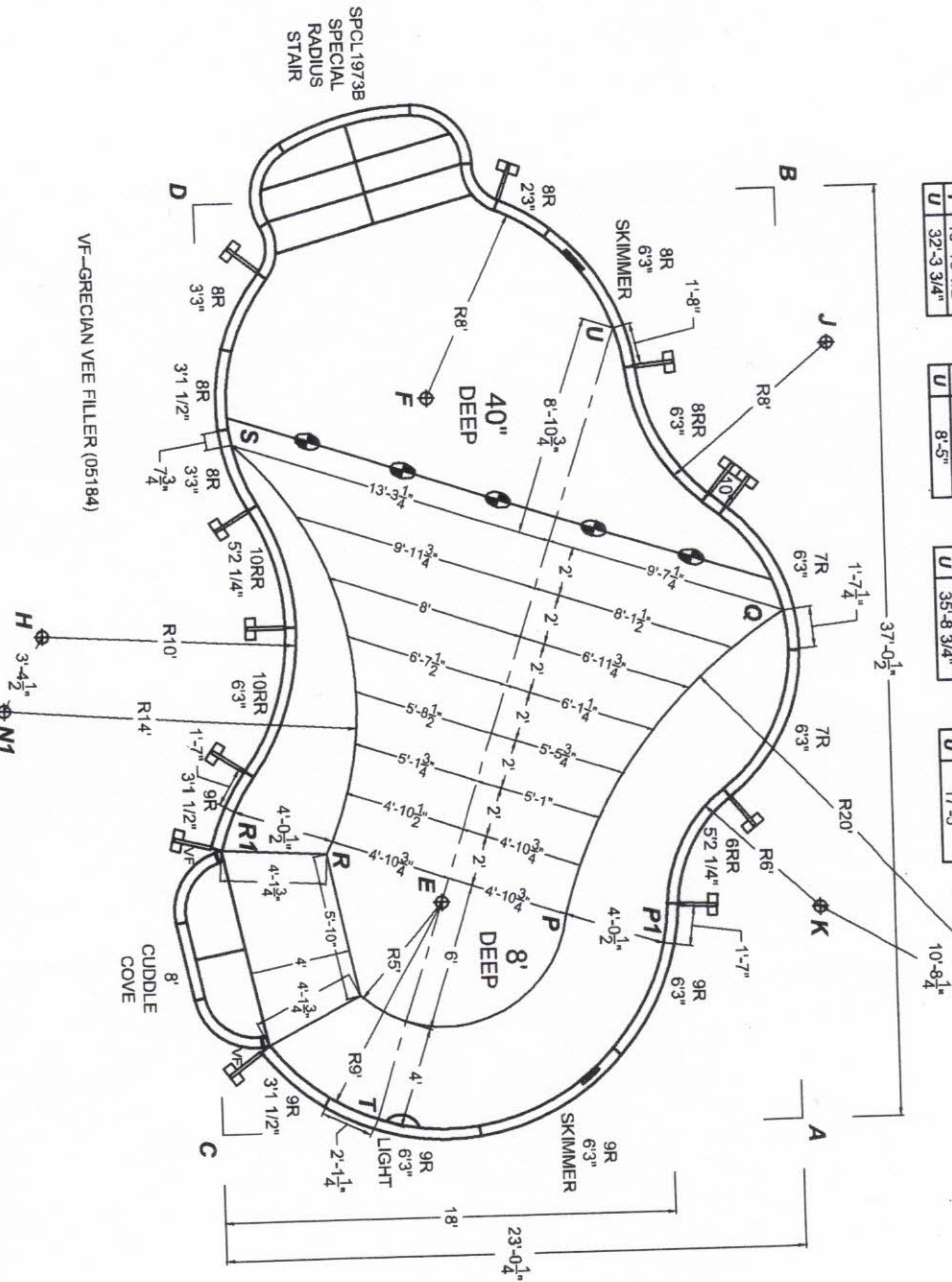

SPECIAL RADIUS STAIR

VF-GRECIAN VEE FILLER (05184)

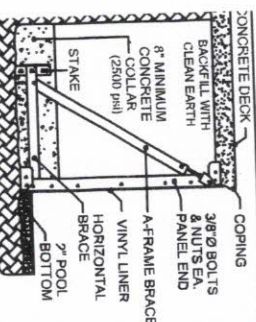

FILE NUMBER : 20102955

Perimeter : 98'-2 1/4"

Surface Area : 599.71 SQ FT

Volume : 19,655 gal.

33 Wade Rd.
Latham, NY 12110
phn: 518-786-1200
fax: 518-786-0954

Imperial Pools

THIS POOL CONFORMS TO CURRENT APSP/ANSI/ICC-5 2011 & ISPPSC 2018 STANDARDS FOR RESIDENTIAL INGROUND SWIMMING POOLS

DEALER NAME : B&B

CUSTOMER NAME : CURLEY

STEEL

CUSTOMER SIGNATURE REQUIRED _____ **DATE** _____

WARNING: SWIMMING POOLS CAN BE DANGEROUS WHEN USED IMPROPERLY. CONSULT YOUR DEALER FOR SAFETY INFORMATION ON SAFE USE. IT IS THE RESPONSIBILITY OF TOWN OFFICIALS, BUILDERS AND THE HOMEOWNERS TO FOLLOW ALL SAFETY RECOMMENDATIONS OF ANSIVSP, LOCAL ORDINANCES AND EQUIPMENT MANUFACTURERS.

DEPTH AND SHAPE OF POOL, MEET MINIMUM STANDARDS OF THE INTERNATIONAL SWIMMING POOL AND SPA CODE SECTION 609. EQUIPMENT AND SUPPLIES MUST BE PROVIDED IN ACCORDANCE WITH THE NATIONAL ELECTRICAL CODE PER IAPMO. ALL A-FRAME BRACES ARE TO BE MOUNDED WITH MINIMUM 8 INCH DEEP Poured 2800 P.S.I. CONCRETE COLLAR AROUND ENTIRE PERIMETER OF POOL. NO DIVING LABELS ARE TO BE INSTALLED AROUND THE PERIMETER OF POOL. ACCORDANCE WITH ANSIVSP/ICC-5.

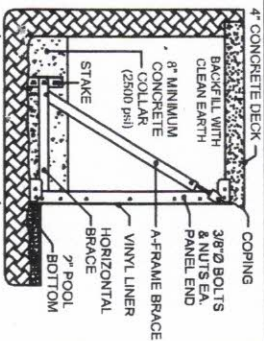

FILE NUMBER : 20102955

Perimeter : 98'-2 1/4"

Surface Area : 599.71 SQ FT

Volume : 19,655 gal.

DRAWN BY : Bparker

SCALE : n/a

33 Wade Rd.
Latham, NY 12110
phn: 518-786-1200
fax: 518-786-0954

THIS POOL CONFORMS TO CURRENT APSP/ANSI/ICC-5 2011 & ISPSFC 2018 STANDARDS FOR RESIDENTIAL INGROUND SWIMMING POOLS

Imperial POOLS

DEALER NAME : B&B
CUSTOMER NAME : CURLEY

CUSTOMER SIGNATURE REQUIRED _____

DATE _____

STEEL

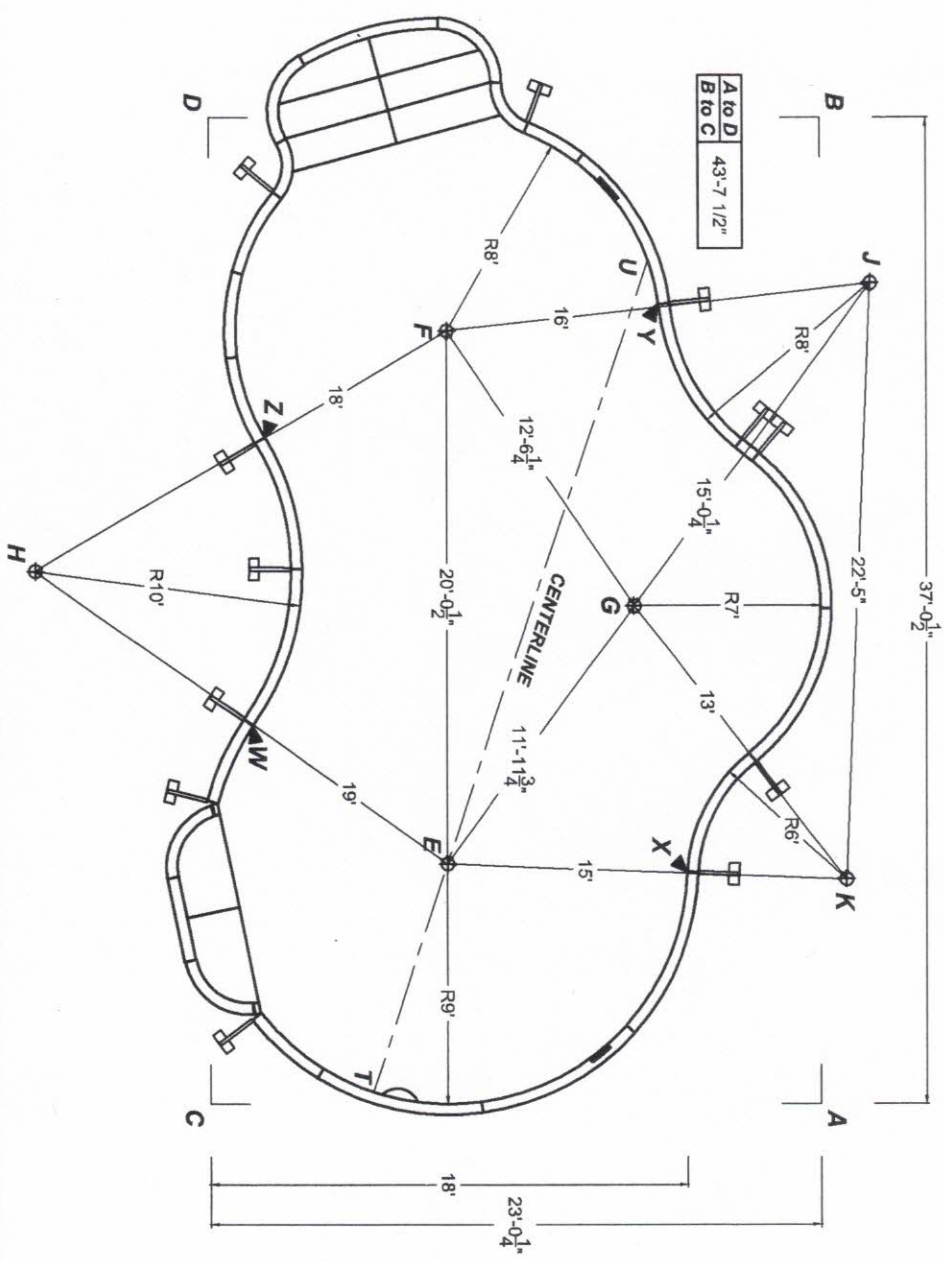

FROM A TO:

E	16'-8"
F	32'-3"
G	19'-1 1/2"
H	35'-8"
J	30'-10 1/2"
K	8'-5 3/4"
W	25'-8"
X	10'-0 1/2"
Y	30'-7 3/4"
Z	32'-7 1/4"

FROM B TO:

E	31'-4 1/4"
F	16'-1 3/4"
G	19'-7 3/4"
H	34'-1 3/4"
J	6'-6"
K	28'-7 3/4"
W	31'-4"
X	10'-0 1/2"
Y	9'-3 1/2"
Z	24'-1 3/4"

FROM C TO:

E	12'-8 3/4"
F	30'-5"
G	24'-7 1/2"
H	20'-1 1/2"
J	39'-7 1/2"
K	25'-5"
W	14'-3"
X	19'-9 1/2"
Y	34'-5 3/4"
Z	25'-1"

FROM D TO:

E	29'-5 1/2"
F	12'-0 1/2"
G	24'-4 1/2"
H	18'-3 3/4"
J	25'-8"
K	37'-4 1/4"
W	22'-1 1/4"
X	33'-7"
Y	18'-4"
Z	12'-2 3/4"

FROM T TO:

E	9'
F	28'-8 3/4"
G	20'-8 3/4"
H	23'-3"
J	35'-8"
K	19'-6 1/4"
W	14'-5"
X	14'-5"
Y	31'-5 3/4"
Z	24'-10 1/2"

FROM U TO:

E	23'-10 3/4"
F	8'
G	12'-11 3/4"
H	25'-10 3/4"
J	8'-4 1/2"
K	24'-4 3/4"
W	23'
X	23'
Y	1'-8"
Z	15'-11"

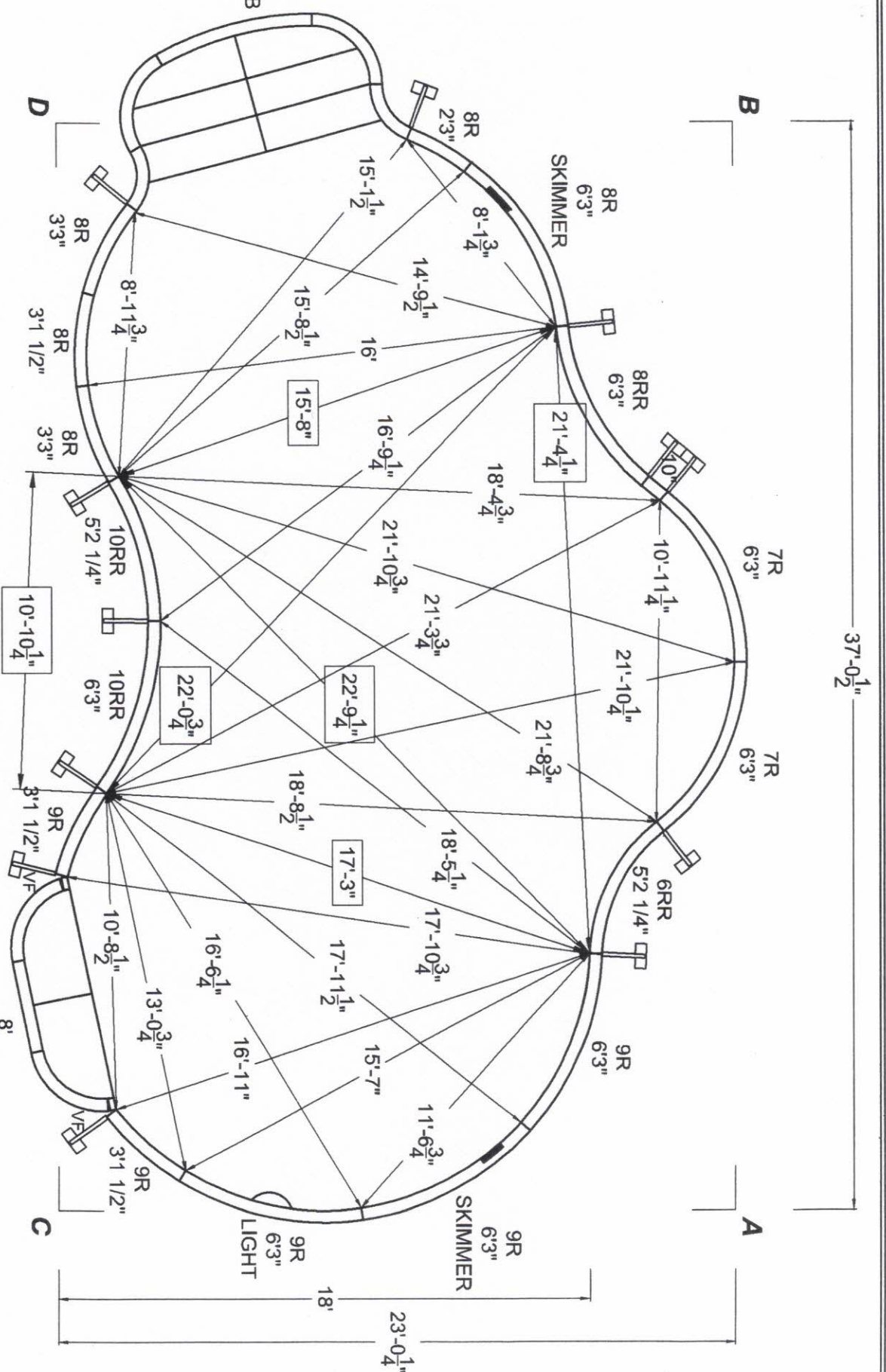

SPCL1973B
SPECIAL
RADIUS
STAIR

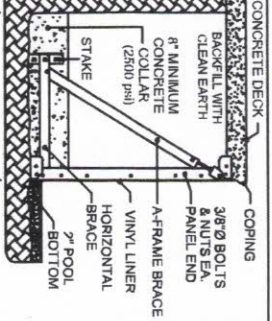

FILE NUMBER : 20102955
Perimeter : 98'-2 1/4"
Surface Area : 599.71 SQ FT
Volume : 19,655 gal.
DRAWN BY : bpartker
SCALE : n/a

33 Wade Rd.
Latham, NY 12110
phn: 518-786-1200
fax: 518-786-0954

THIS POOL CONFORMS TO CURRENT
APSP/ANSI/ICC-5 2011 & ISPSA 2018
STANDARDS FOR RESIDENTIAL
INGROUND SWIMMING POOLS

CUSTOMER SIGNATURE REQUIRED

DEALER NAME: B&B
CUSTOMER NAME: CURLEY

STEEL

DATE

DEPTH AND SHAPE OF POOL, MEET MINIMUM STANDARDS OF THE INTERNATIONAL SWIMMING POOL AND SPA CODE SECTION 609. EQUIPMENT, BONDING MUST BE PROVIDED IN ACCORDANCE WITH THE NATIONAL ELECTRICAL CODE (NEC) AND ALL A-FRAME BRACES ARE TO BE ROUNDED WITH MINIMUM 8 INCH DEEP POUNDED 2500 P.S.I. CONCRETE COLLAR AROUND ENTIRE PERIMETER OF POOL. NO DIVING LABELS ARE TO BE INSTALLED AROUND THE PERIMETER OF POOL. AS REQUIRED. SUCTION ENTRAPMENT AVOIDANCE IS TO BE INSTALLED IN ACCORDANCE WITH ANSI/APSP/ICC-7.

SPCL1973B

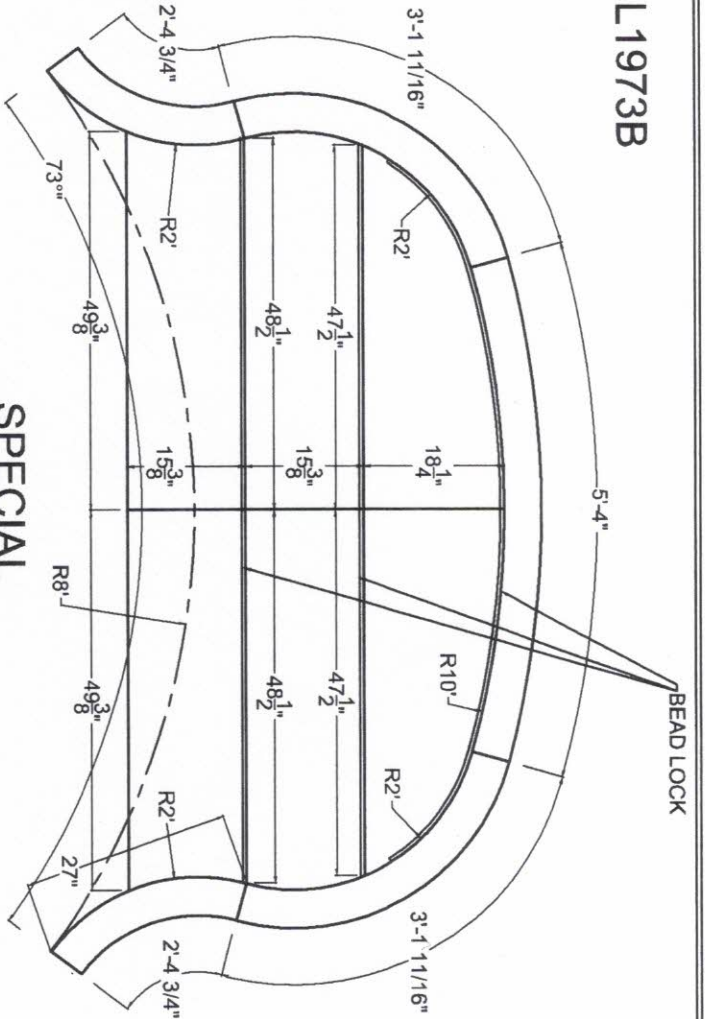

**SPECIAL
RADIUS STAIR**

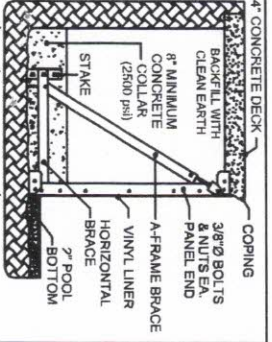
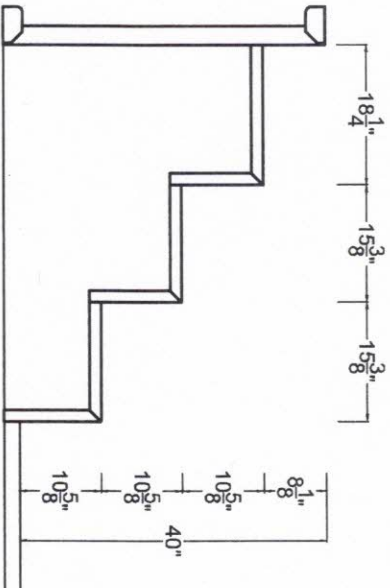

FILE NUMBER : 20102955
Perimeter : 98'-2 1/4"
Surface Area : 599.71 SQ FT
Volume : 19,655 gal.

33 Wade Rd.
 Latham, NY 12110
 phn: 518-786-1200
 fax: 518-786-0954

THIS POOL CONFORMS TO CURRENT
 APSP/ANSI/ICC-5 2011 & ISPSG 2018
 STANDARDS FOR RESIDENTIAL
 INGROUND SWIMMING POOLS

CUSTOMER SIGNATURE REQUIRED _____ **DATE** _____
DEALER NAME: B&B
CUSTOMER NAME: CURLEY
STEEL

WARNING: SWIMMING POOLS CAN BE DANGEROUS WHEN USED IMPROPERLY. CONSULT YOUR DEALER FOR SAFETY INFORMATION ON SAFE USE. IT IS THE RESPONSIBILITY OF THE ACCORDANCE WITH THE 2018 INTERNATIONAL SWIMMING POOL AND SPA CODE SECTION 809. EQUIPMENT, BONDING MUST BE PROVIDED IN ACCORDANCE WITH THE NATIONAL ELECTRICAL CODE (NEC) AND ALL A-FRAME BRACES ARE TO BE MOUNTED WITH MINIMUM 8 INCH DEEP POURED 2500 P.S.I. CONCRETE COLLAR AROUND ENTIRE PERIMETER OF POOL. NO DIVING LABELS ARE TO BE INSTALLED AROUND THE PERIMETER OF POOL AS REQUIRED. SUCTION ENTRAPMENT AVOIDANCE IS TO BE INSTALLED IN ACCORDANCE WITH ANSI/APSP/ICC-7.

FROM A TO:	
D	43'-7 1/2"
N1	35'-6 3/4"
N2	10'-8"
P	12'-4 1/4"
Q	8'-10"
R	20'-2 1/4"
R1	25'-7 1/4"
S	35'-1"
T	18'-10 1/2"
U	32'-3 3/4"

FROM B TO:	
C	43'-7 1/2"
N1	37'-1 1/4"
N2	35'-5 1/2"
P	30'-0 1/2"
Q	30'-4 1/2"
R	16'-10 1/4"
R1	31'-5 1/2"
S	23'-10 3/4"
T	23'-5 1/2"
U	40'-3 1/2"

FROM C TO:	
A	43'-7 1/2"
N1	18'-10 3/4"
N2	33'-4 3/4"
P	18'-3 1/2"
Q	19'-2"
R	30'-6"
R1	12'-5"
S	12'-9 3/4"
T	27'-5 1/2"
U	35'-8 3/4"

FROM D TO:	
A	43'-7 1/2"
N1	21'-7 3/4"
N2	47'-6 1/4"
P	31'-10 1/2"
Q	34'-9 3/4"
R	28'-5"
R1	25'-11 3/4"
S	24'-3 1/4"
T	9'-8 1/4"
U	37'-1 1/4"

FROM T TO:	
N1	21'-1 1/4"
N2	27'-2 3/4"
P	11'-1 3/4"
Q	13'-5"
R	25'-10 1/4"
R1	13'-5"
S	27'-5"

FROM U TO:	
N1	28'-9 1/4"
N2	33'-1"
P	23'-5"
Q	24'-7"
R	13'-1"
R1	24'-7"
S	15'-11 1/2"

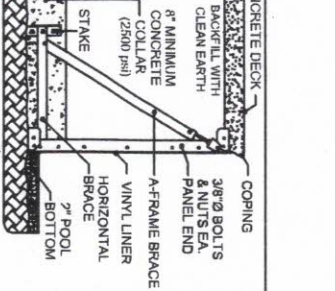
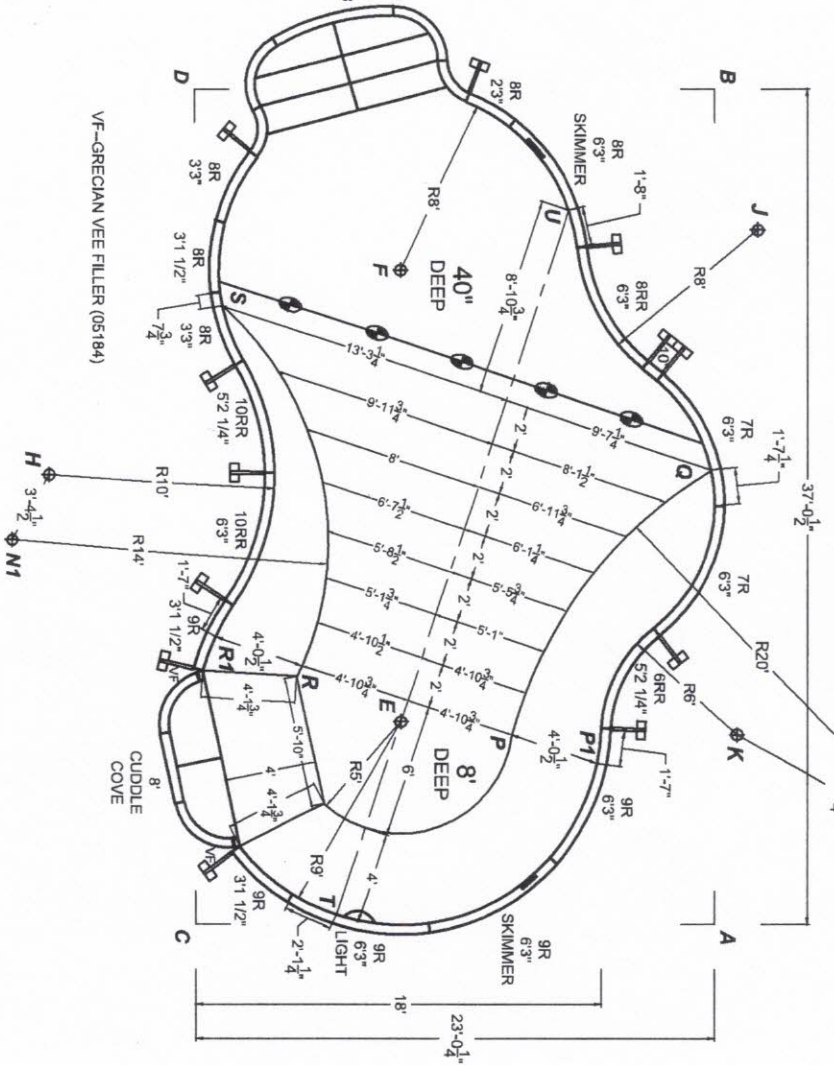

FILE NUMBER : 20102955
Perimeter : 98'-2 1/4"
Surface Area : 599.71 SQ FT
Volume : 19,655 gal.
DRAWN BY : barker

33 Wade Rd.
Latham, NY 12110
phn: 518-786-1200
fax: 518-786-0954

Imperial Pools

THIS POOL CONFORMS TO CURRENT APSP/ANSI/ICC-5 2011 & ISPS 2018 STANDARDS FOR RESIDENTIAL INGROUND SWIMMING POOLS

DEALER NAME : B&B
CUSTOMER NAME : CURLEY
DATE :

QUANTITY	NAME	UNIVERSAL	LEGACY ONLY
1	10' REVERSE RADIUS PANEL 52 1/4"	04300	04300
1	10' REVERSE RADIUS PANEL 63"	04301	04301
1	10' PLAIN PANEL	04131	04131
2	45' GRECIAN VEE FILLER 2x2"	05184	05184
2	6" REVERSE RADIUS PANEL 52 1/4"	04071	04071
2	7' RADIUS PANEL 63"	04434	04434
1	8' CUDDLE COVE 2' RAD COMPLETE W/ BEAD & HARDWARE	04088B	04088B
1	8' RADIUS PANEL 23"	04184	04184
1	8' RADIUS PANEL 31 1/2"	04133	04133
2	8' RADIUS PANEL 33"	04163	04163
1	8' RADIUS SKIMMER PANEL 63" 1084	04476	04476
1	8' REVERSE RADIUS PANEL 63"	04165	04165
1	9' RADIUS LIGHT PANEL 63"	04444	04444
2	9' RADIUS PANEL 31 1/2"	04173	04173
1	9' RADIUS PANEL 63"	04170	04170
1	9' RADIUS SKIMMER PANEL 63" 1084	04172	04172
12	A-FRAME	VARIABLES	VARIABLES
1	SPECIAL 1973B	SPECIAL	SPECIAL
0	75 PACK HEX BOLT AND WASHER	PAK75	PAK75
0	100 PACK HEX BOLT AND WASHER	PAK100	PAK100

1) ITEMS MARKED WITH AN ASTERISK (*) ARE NOT NORMALLY STOCKED IN BRANCHES - PLEASE CHECK STOCK BEFORE ORDERING. 2) CODE NUMBERS 0410088, 0410025, 0410057, 0410067, 0410068 AND SPECIAL DENOTE A SPECIAL ITEM - PLEASE CHECK WITH YOUR LOCAL BRANCH FOR LEAD TIME. AVAILABILITY AND PRICING. 3) ALL SARATOGA STEP CODES ARE THE BASIC, WHITE VERSIONS - PLEASE CHECK WITH YOUR BRANCH FOR OTHER VERSIONS. 4) HARDWARE ESTIMATE DOES NOT INCLUDE HARDWARE TO CONSTRUCT SPECIALS - PLEASE CONTACT CORPORATE SERVICES FOR REQUIRED ADDITIONAL HARDWARE INFORMATION.