

FROM A TO:	
D	43'-7 1/2"
M1	35'-6 3/4"
N2	10'-8"
P	12'-4 1/4"
P1	8'-10"
Q	20'-2 1/4"
R	21'-8"
R1	25'-7 1/4"
S	35'-1"
T	16'-10 1/2"
U	32'-3 3/4"

FROM B TO:	
C	43'-7 1/2"
M1	37'-1 1/4"
N2	35'-5 1/2"
P	30'-0 1/2"
P1	30'-4 1/2"
Q	16'-10 1/4"
R	31'-5 1/2"
R1	32'-10 3/4"
S	23'-10 1/2"
T	40'-3 1/2"
U	8'-5"

FROM C TO:	
B	43'-7 1/2"
M1	18'-10 3/4"
N2	33'-4 3/4"
P	16'-3 1/2"
P1	19'-2"
Q	30'-6"
R	12'-5"
R1	12'-9 3/4"
S	27'-5 1/2"
T	6'-2"
U	35'-8 3/4"

FROM D TO:	
A	43'-7 1/2"
M1	21'-7 3/4"
N2	47'-6 1/4"
P	31'-10 1/2"
P1	34'-9 3/4"
Q	28'-5"
R	25'-11 3/4"
R1	24'-3 1/4"
S	9'-8 1/4"
T	37'-1 1/4"
U	17'-5"

FROM T TO:	
M1	21'-11"
N2	27'-2 3/4"
P	11'-1 3/4"
P1	13'-5"
Q	25'-10 1/4"
R	11'-1 3/4"
S	13'-5"
T	27'-5"

FROM U TO:	
N1	28'-9 1/4"
N2	33'-1"
P	23'-5"
P1	24'-7"
Q	13'-1"
R	23'-5"
R1	24'-7"
S	15'-11 1/2"

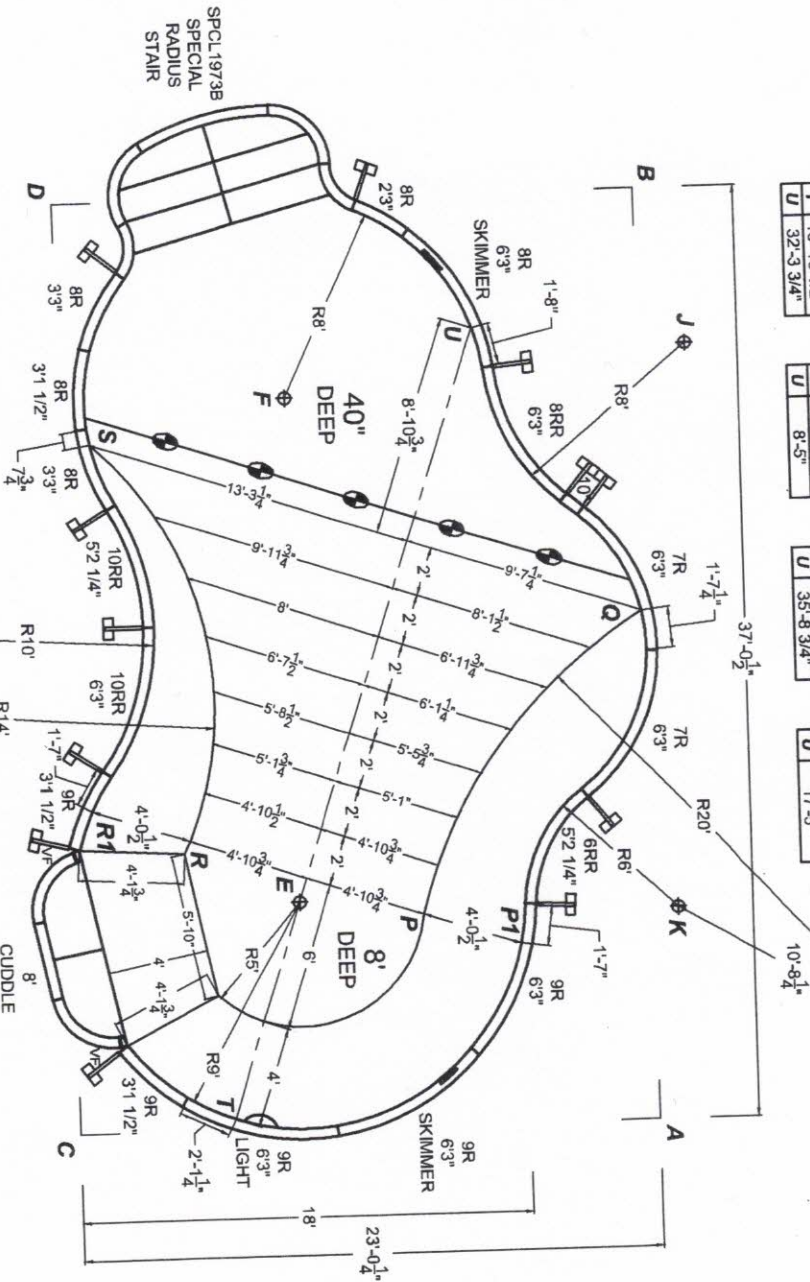

SPECIAL RADIUS STAIR

VF-GRECIAN VEE FILLER (05184)

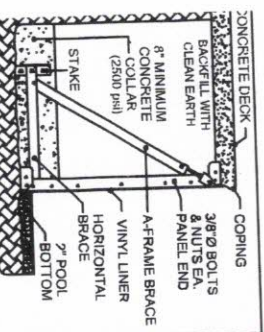

**FILE NUMBER : 20102955**  
 Perimeter : 98'-2 1/4"  
 Surface Area : 599.71 SQ FT  
 Volume : 19,655 gal.

33 Wade Rd.  
 Latham, NY 12110  
 phn: 518-786-1200  
 fax: 518-786-0954

**Imperial Pools**  
 THIS POOL CONFORMS TO CURRENT APSP/ANSI/ICC-5 2011 & ISPS 2018 STANDARDS FOR RESIDENTIAL INGROUND SWIMMING POOLS

**DEALER NAME : B&B**  
**CUSTOMER NAME : CURLEY**

**STEEL**

**CUSTOMER SIGNATURE REQUIRED** \_\_\_\_\_ **DATE** \_\_\_\_\_

WARNING: SWIMMING POOLS CAN BE DANGEROUS WHEN USED IMPROPERLY. CONSULT YOUR DEALER FOR SAFETY INFORMATION ON SAFE USE. IT IS THE RESPONSIBILITY OF TOWN OFFICIALS, BUILDERS AND THE HOMEOWNERS TO FOLLOW ALL SAFETY RECOMMENDATIONS OF ANSISP, LOCAL ORDINANCES AND EQUIPMENT MANUFACTURERS. DEPTH AND SHAPE OF POOL, MEET MINIMUM STANDARDS OF THE INTERNATIONAL SWIMMING POOL AND SPA CODE SECTION 609. EQUIPMENT AND SUPPLIES MUST BE PROVIDED IN ACCORDANCE WITH THE NATIONAL ELECTRICAL CODE PER IAPMO. ALL A-FRAME BRACES ARE TO BE MOUNDED WITH MINIMUM 8 INCH DEEP Poured 2800 P.S.I. CONCRETE COLLAR AROUND ENTIRE PERIMETER OF POOL. NO DIVING LABELS ARE TO BE INSTALLED AROUND THE PERIMETER OF POOL. ACCORDANCE WITH ANSISP/ICC-5.

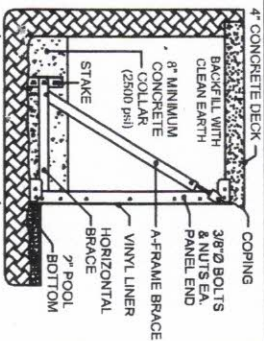

**FILE NUMBER :** 20102955

**Perimeter :** 98'-2 1/4"

**Surface Area :** 599.71 SQ FT

**Volume :** 19,655 gal.

**DRAWN BY :** Bparker

33 Wade Rd.  
Latham, NY 12110  
phn: 518-786-1200  
fax: 518-786-0954

**THIS POOL CONFORMS TO CURRENT APSP/ANSI/ICC-5 2011 & ISPSFC 2018 STANDARDS FOR RESIDENTIAL INGROUND SWIMMING POOLS**

**DEALER NAME :** B&B  
**CUSTOMER NAME :** CURLEY

**STEEL**

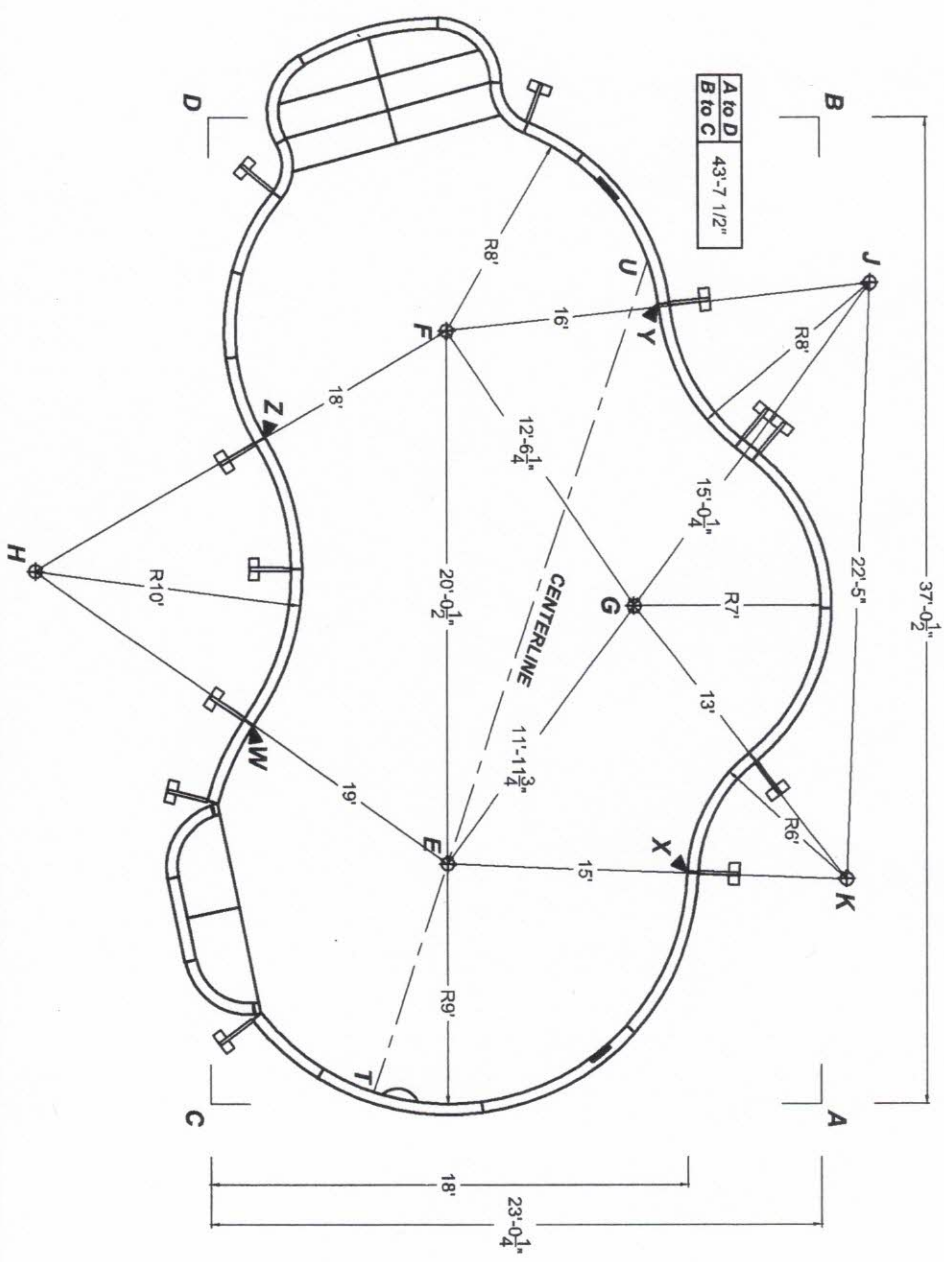

<b>FROM A TO:</b>	
E	16'-8"
F	32'-3"
G	19'-1 1/2"
H	35'-8"
J	30'-10 1/2"
K	8'-5 3/4"
W	25'-8"
X	10'-0 1/2"
Y	30'-7 3/4"
Z	32'-7 1/4"

<b>FROM B TO:</b>	
E	31'-4 1/4"
F	16'-1 3/4"
G	19'-7 3/4"
H	34'-1 3/4"
J	6'-6"
K	28'-7 3/4"
W	31'-4"
X	10'-0 1/2"
Y	9'-3 1/2"
Z	24'-1 3/4"

<b>FROM C TO:</b>	
E	12'-8 3/4"
F	30'-5"
G	24'-7 1/2"
H	20'-11 3/4"
J	39'-7 1/2"
K	25'-5"
W	14'-3"
X	19'-9 1/2"
Y	34'-5 3/4"
Z	25'-1"

<b>FROM D TO:</b>	
E	29'-5 1/2"
F	12'-0 1/2"
G	24'-4 1/2"
H	18'-3 3/4"
J	25'-8"
K	37'-4 1/4"
W	22'-11 1/4"
X	33'-7"
Y	18'-4"
Z	12'-2 3/4"

<b>FROM T TO:</b>	
E	9'
F	28'-8 3/4"
G	20'-8 3/4"
H	23'-3"
J	35'-8"
K	19'-6 1/4"
W	14'-5"
X	14'-5"
Y	31'-5 3/4"
Z	24'-10 1/2"

<b>FROM U TO:</b>	
E	23'-10 3/4"
F	8'
G	12'-11 3/4"
H	25'-10 3/4"
J	8'-4 1/2"
K	24'-4 3/4"
W	23'
X	23'
Y	1'-8"
Z	15'-11"



SPCL1973B

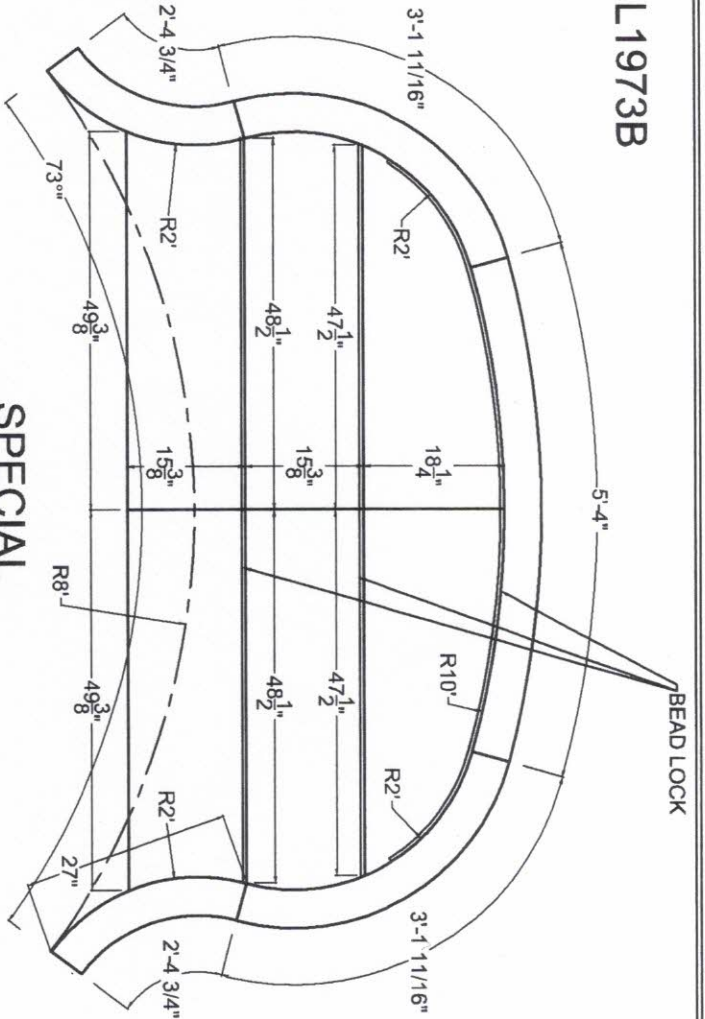

**SPECIAL  
RADIUS STAIR**

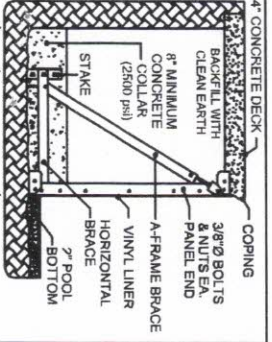
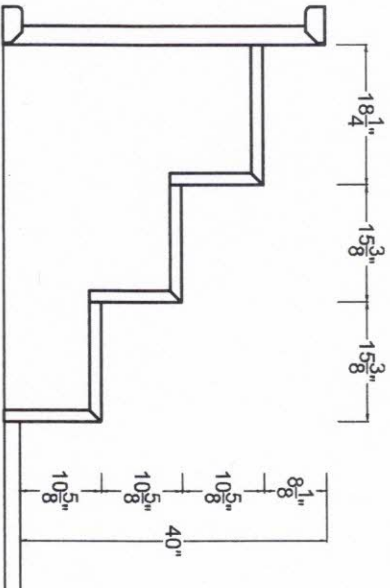

<b>FILE NUMBER :</b> 20102955	THIS POOL CONFORMS TO CURRENT <i>ASPP/ANSI/ICC-5 2011 &amp; ISRSC 2018</i> STANDARDS FOR RESIDENTIAL INGROUND SWIMMING POOLS		<b>CUSTOMER SIGNATURE REQUIRED</b>	<b>DATE</b>
<b>Perimeter :</b> 98'-2 1/4"	33 Wade Rd. Latham, NY 12110 phn: 518-786-1200 fax: 518-786-0954		<b>DEALER</b> B&B	
<b>Surface Area :</b> 599.71 SQ FT			<b>CUSTOMER</b> CURLEY	
<b>Volume :</b> 19,655 gal.			<b>STEEL</b>	
<b>DRAWN BY :</b> bparker	<b>SCALE</b> n/a	<small>WARNING: SWIMMING POOLS CAN BE DANGEROUS WHEN USED IMPROPERLY. CONSULT YOUR DEALER FOR SAFETY INFORMATION ON SAFE USE. IT IS THE RESPONSIBILITY OF TOWN OFFICIALS, BUILDERS AND THE HOMEOWNERS TO FOLLOW ALL SAFETY RECOMMENDATIONS OF ASSAPSP, LOCAL ORDINANCES AND EQUIPMENT MANUFACTURERS. DEPTH AND SHAPE OF POOL MEET MINIMUM STANDARDS OF THE INTERNATIONAL SWIMMING POOL AND SPA CODE 2018 FOR IN-GROUND SWIMMING POOLS. A MEANS ENTRY/EXIT FOR BOTH THE DEEP END AND THE SHALLOW END OF THE POOL MUST BE PROVIDED IN ACCORDANCE WITH THE 2018 INTERNATIONAL SWIMMING POOL AND SPA CODE SECTION 809. EQUIPMENT, BONDING MUST BE PROVIDED IN ACCORDANCE WITH THE NATIONAL ELECTRICAL CODE NFPA 70. ALL A-FRAME BRACES ARE TO BE MOUNDED WITH MINIMUM 8 INCH DEEP POURED 2500 P.S.I. CONCRETE COLLAR AROUND ENTIRE PERIMETER OF POOL. NO DIVING LABELS ARE TO BE INSTALLED AROUND THE PERIMETER OF POOL AS REQUIRED. SUCTION ENTRAPMENT AVOIDANCE IS TO BE INSTALLED IN ACCORDANCE WITH ANSI/APSP/ICC-7.</small>		

